



102745-XT electric fireplace
with optional log set

ELECTRIC FIREPLACES

DEEP • EXTRA TALL • EXTRA SLIM • BAY • WM • WM SLIM • CLASSIC



EXTRA SLIM



102735-XS electric fireplace



102765-XS electric fireplace



35"



45"



55"









65"

The Remii NEW Extra Slim is available in four sizes, so you'll find a unit that is perfect for any space in your home, business or commercial space.

Boasting our FIRE & ICE® Flame presentation with three color LED light strips allowing for multi-color flame options. With just a click of the included remote control, choose from blue, rose, violet, yellow or orange colored flames. The Extra Slim model comes standard with Canyon Brown and Ocean Blue fireglass media. Additional media options available for purchase, please see back page for more details.

KEY FEATURES: Extra Slim

-  Heater & Fan
-  Rated for indoor & outdoor use including bathrooms
-  Perfect for zone heating. Approx. 500 sq. ft. 5000 BTUs
-  Hard-wire ready
Thermostat hard-wire ready
-  Very thin - only 4" in depth
-  FIRE & ICE® Flame presentation. Three light strips allow for yellow, orange, blue, violet & rose colored flames

	102735-XS	102745-XS	102755-XS	102765-XS
Volts	120 AC / 60 Hz	120 AC / 60 Hz	120 AC / 60 Hz	120 AC / 60 Hz
Watts	1500 max	1500 max	1500 max	1500 max
No Heater	25 watts	25 watts	25 watts	25 watts
Motor Heater	19 watts	19 watts	19 watts	19 watts
Height, Width, Depth	19 7/8" x 34 1/8" x 4"	19 7/8" x 44 1/8" x 4"	19 7/8" x 54 1/8" x 4"	19 7/8" x 64 1/8" x 4"
Gross Weight	46.3 lbs	62 lbs	86 lbs	108 lbs
Plug Location	Left Side	Left Side	Left Side	Left Side
Cord Length	70 7/8	70 7/8	70 7/8	70 7/8
Rough Wall Opening	34" x 20 3/8"	44" x 20 3/8"	54" x 20 3/8"	64" x 20 3/8"
BTU	5000	5000	5000	5000

IN THE BOX



Canyon Brown Media



Ocean Blue Media

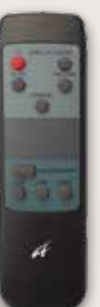

*Remote control may not be exactly as shown

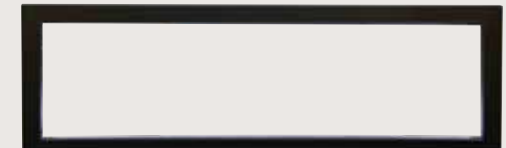



102755-XS electric fireplace



102745-XS electric fireplace

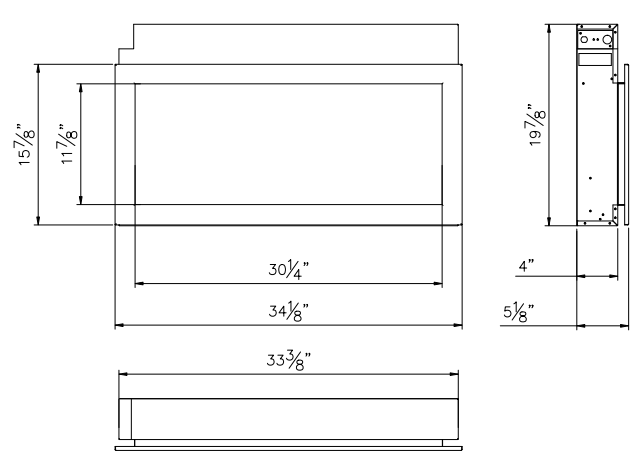

102735-XS

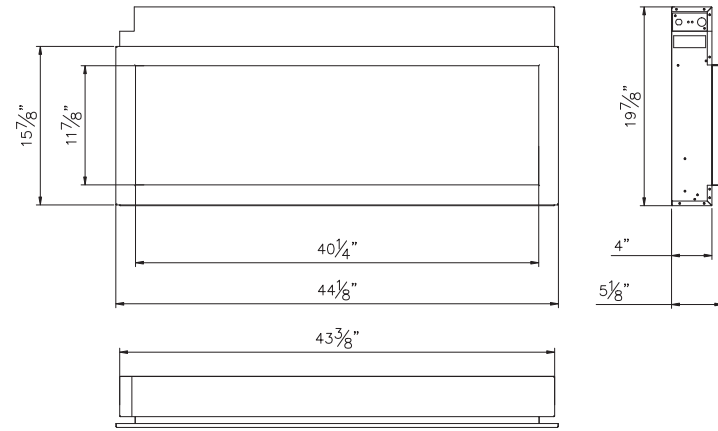

102745-XS

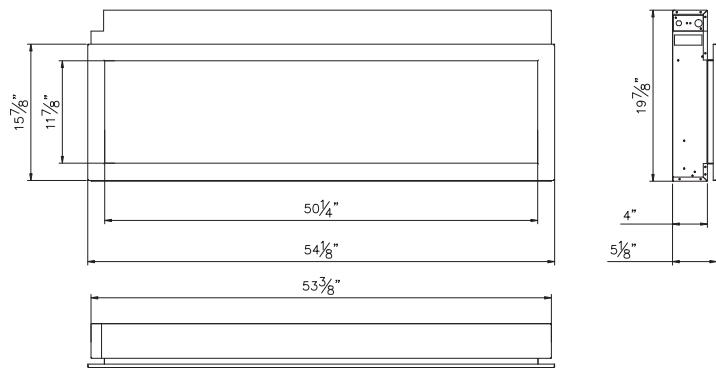

102755-XS

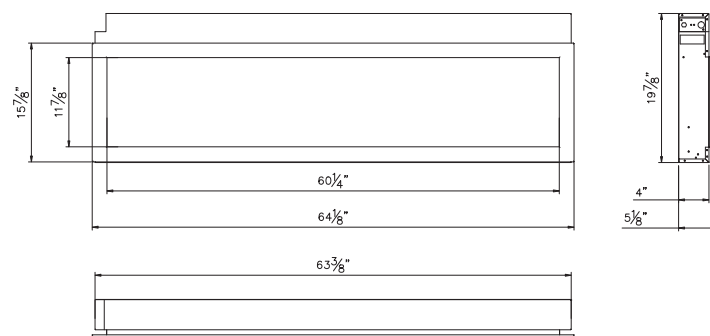

102765-XS



102765-XS electric fireplace

DEEP



102755-DE electric fireplace with optional log set



102745-DE electric fireplace



45"



55"









65"

The Remii Deep Series of built-in electric fireplaces have been designed to give you the maximum in flexibility in selecting a unit that perfectly suits your needs.

Our stylish electric fireplace will be a focal point in any room, indoor or outdoor. The Deep Series gives you a 12" depth and multiple length options, as well as giving you the ability to install your fireplace with your choice of finishing material built right to the glass for a "clean face" design or using the provided black metal surround. Your choice – your design!

Featuring the vibrant Fire & Ice® flame set, with just a click of your remote you can easily change the flame colour from blue to purple to violet to orange or yellow. Additional media options available for purchase, please see back page for more details.

KEY FEATURES: Deep

-  FIRE & ICE® Flame presentation. Three light strips allow for yellow, orange, blue, violet & rose colored flames
-  Heater & Fan Flame operates with or without heat
-  Perfect for zone heating. Approx. 500 sq. ft. 5000 BTUs
-  Hard-wire ready Thermostat hard-wire ready
-  Illuminate decorative media like never before with ambient canopy lighting in 13 colors
-  Deep 12" comes with with Canyon Brown and Ocean Blue fireglass media, and black steel surround that can be installed if preferred

	102745-DE	102755-DE	102765-DE
Volts	120 AC / 60 Hz	120 AC / 60 Hz	120 AC / 60 Hz
Watts	1500 max	1500 max	1500 max
No Heater	25 watts	25 watts	25 watts
Motor Heater	19 watts	19 watts	19 watts
Height, Width, Depth	23 5/8" x 44 1/8" x 11 7/8"	23 5/8" x 54 1/8" x 11 7/8"	23 5/8" x 64 1/8" x 11 7/8"
Gross Weight	103.6 lbs	121 lbs	143 lbs
Plug Location	Left Side	Left Side	Left Side
Cord Length	70 7/8	70 7/8	70 7/8
Rough Wall Opening	45" x 25"	55" x 25"	65" x 25"
BTU	5000	5000	5000

IN THE BOX



Canyon Brown Media

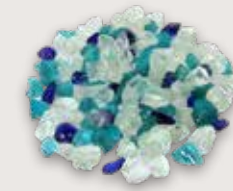

Ocean Blue Media

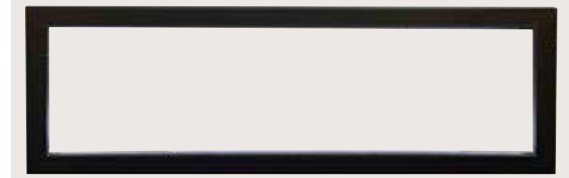

Additional media options available for purchase including life like log sets, please see back page for more details.



102765-DE electric fireplace



102745-DE electric fireplace

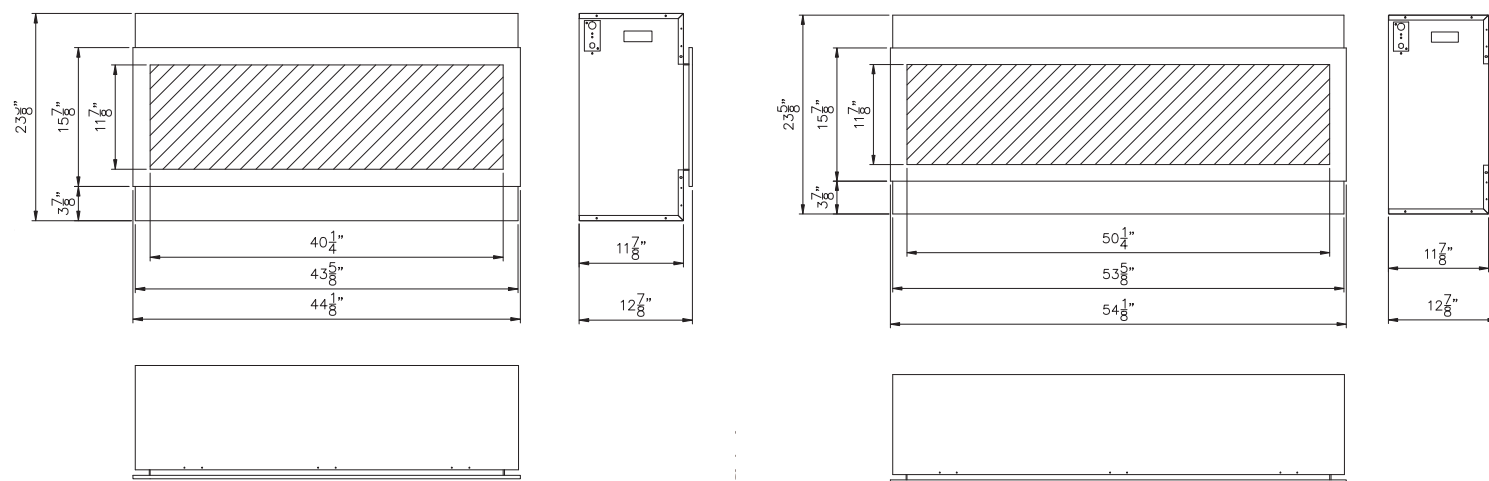

102745-DE

102755-DE

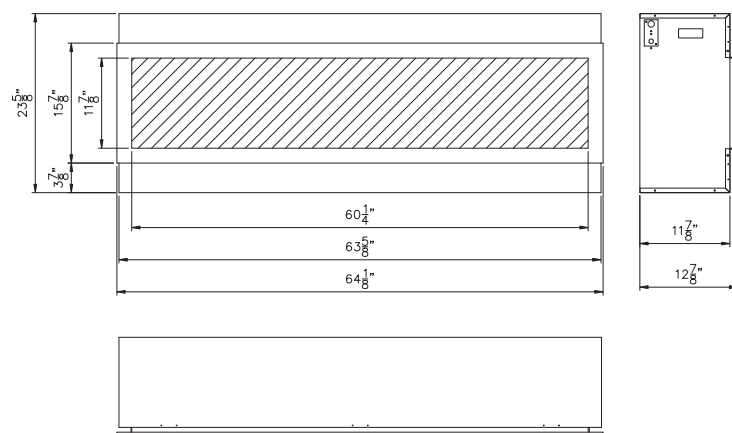

102765-DE



102755-DE electric fireplace

EXTRA TALL



102765-XT electric fireplace



102755-XT electric fireplace



45"



55"









65"

Featuring an Extra Tall viewing area that is 18" in height! That is 6" taller than our other Remii models. It has a deep media tray and comes standard with Canyon Brown and Ocean Blue fireglass media. Additional media options available for purchase, please see back page for more details.

Built with Amantii's FIRE & ICE® Flame presentation made of three color LED light strips allowing for multi-color flame options. With just a click of the included remote control, choose from blue, rose, violet, yellow or orange colored flames.

KEY FEATURES: Extra Tall

-  Heater & Fan
-  Rated for indoor & outdoor use including bathrooms
-  Perfect for zone heating. Approx. 500 sq. ft. 5000 BTUs
-  Hard-wire ready
Thermostat hard-wire ready
-  ^{18"} Glass viewing area is 18" in height
-  FIRE & ICE® Flame presentation. Three light strips allow for yellow, orange, blue, violet & rose colored flames

	102745-XT	102755-XT	102765-XT
Volts	120 AC / 60 Hz	120 AC / 60 Hz	120 AC / 60 Hz
Watts	1500 max	1500 max	1500 max
No Heater	25 watts	25 watts	25 watts
Motor Heater	19 watts	19 watts	19 watts
Height, Width, Depth	29 1/2" x 43 5/8" x 12 5/8"	29 1/2" x 53 5/8" x 12 5/8"	29 1/2" x 63 5/8" x 12 5/8"
Gross Weight	94.6 lbs	110 lbs	127.6 lbs
Plug Location	Left Side	Left Side	Left Side
Cord Length	70 7/8	70 7/8	70 7/8
Rough Wall Opening	45" x 30"	55" x 30"	65" x 30"
BTU	5000	5000	5000

IN THE BOX



Canyon Brown Media

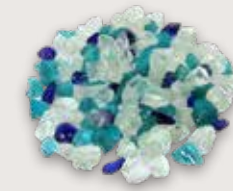

Ocean Blue Media



Additional media options available for purchase including life like log sets, please see back page for more details.



102765-XT electric fireplace



102745-XT electric fireplace

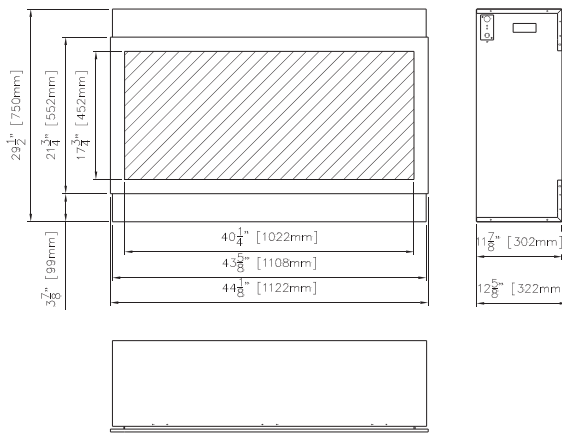

102745-XT

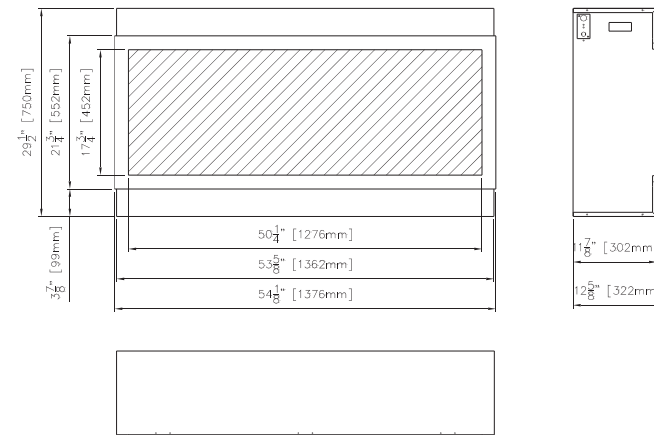

102755-XT

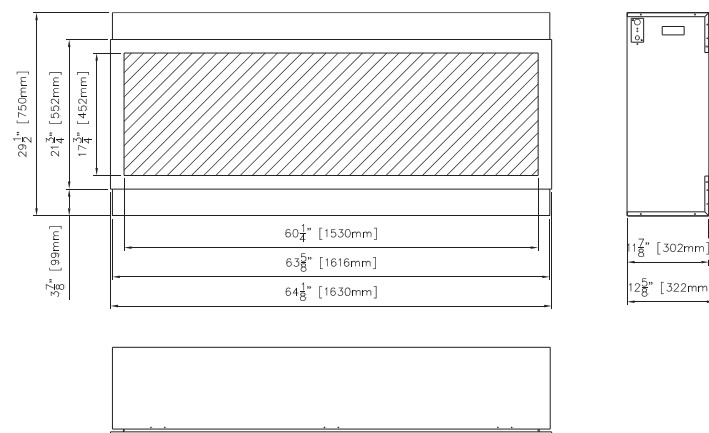

102765-XT



102755-XT electric fireplace

BAY SERIES



30-BAY-SLIM electric fireplace

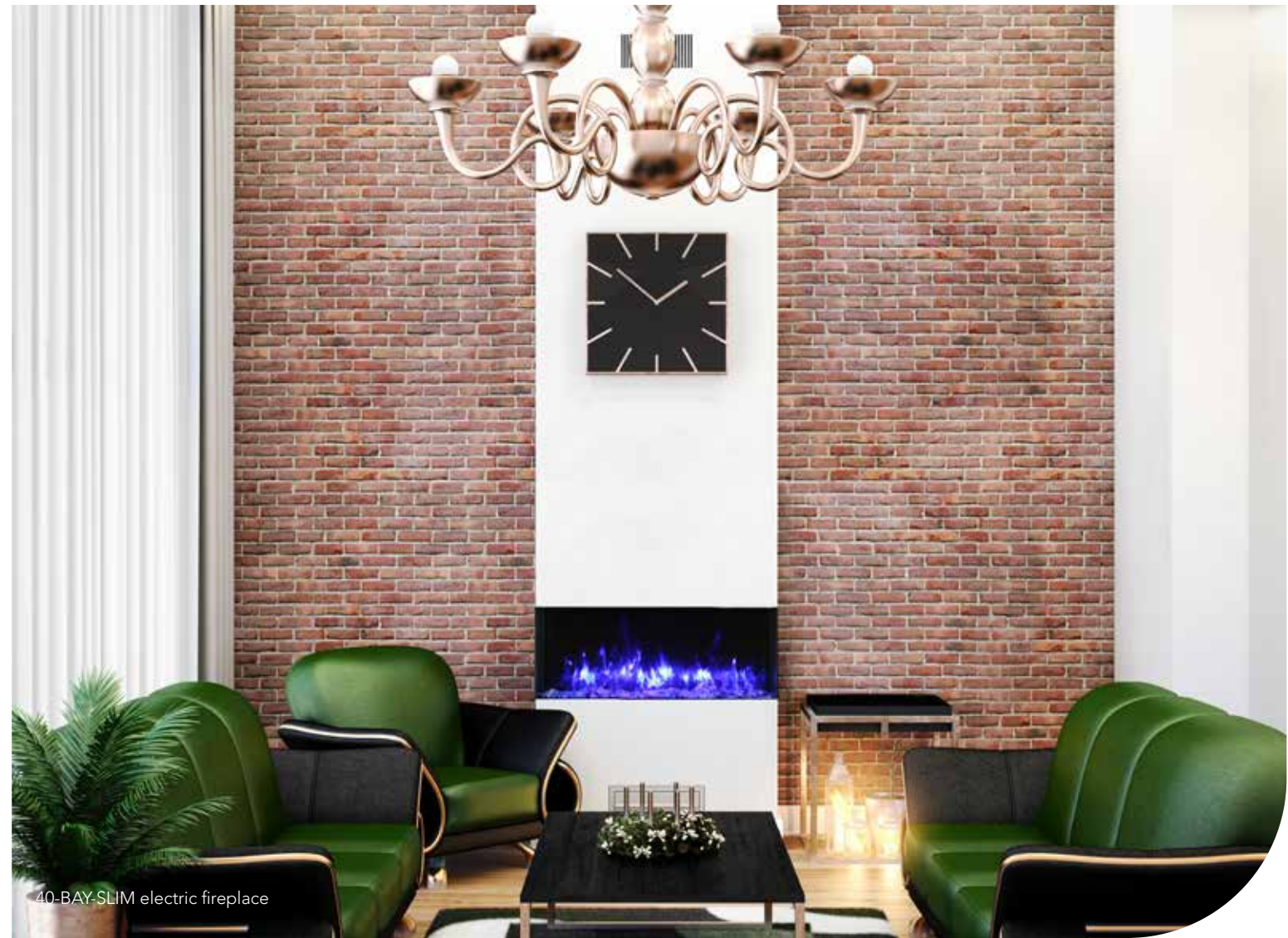









40-BAY-SLIM electric fireplace



With a depth of less than 4", the Bay series of electric fireplaces is designed to be installed into a 2" x 4" wall. Available in five sizes, you'll find a unit that is perfect for any space in your home, business or commercial space. The Bay is perfectly suited to installations where wall depth is at a premium.

The Bay model comes standard with a 10 Piece Birch Style Log Set, two colors of real fireglass and two colors of vermiculite.

KEY FEATURES: Bay

-  State-of-the-art FIRE & ICE® flame set, with a click of the remote, change the flame from traditional colors such as yellow and orange to more contemporary colors like blue, purple, rose and violet.
-  Ambient canopy lighting in 13 colors illuminates media like never before
-  Comes with a 10 piece log set and charcoal grey fire glass, vermiculite, black fire glass plus a remote.
-  2 Stage Heater
Flame operates with or without heat
Remote control for flame and heater
-  Very thin – only 4" in depth
-  Thermostat hard-wire ready
Electrical hard-wire ready
-  Approved for Indoor and Outdoor Use
-  Can produce up to 5000 BTU of heat, enough to heat up to 500 sq feet

	30-BAY-SLIM	40-BAY-SLIM	50-BAY-SLIM	60-BAY-SLIM	72-BAY-SLIM
Volts	120 AC / 60 Hz	120 AC / 60 Hz	120 AC / 60 Hz	120 AC / 60 Hz	120 AC / 60 Hz
Watts	1500 max	1500 max	1500 max	1500 max	1500 max
No Heater	25 watts	25 watts	25 watts	25 watts	25 watts
Motor Heater	19 watts	19 watts	19 watts	19 watts	19 watts
Height, Width, Depth	26 5/8" x 33 1/4" x 4"	26 5/8" x 43 1/4" x 4"	26 5/8" x 53 1/4" x 4"	26 5/8" x 63 1/4" x 4"	26 5/8" x 73 1/4" x 4"
Gross Weight	85 lbs	104 lbs	121 lbs	140 lbs	167 lbs
Plug Location	Left Side	Left Side	Left Side	Left Side	Left Side
Cord Length	70 7/8	70 7/8	70 7/8	70 7/8	70 7/8
Rough Wall Opening					
BTU	5000	5000	5000	5000	5000





SLIM

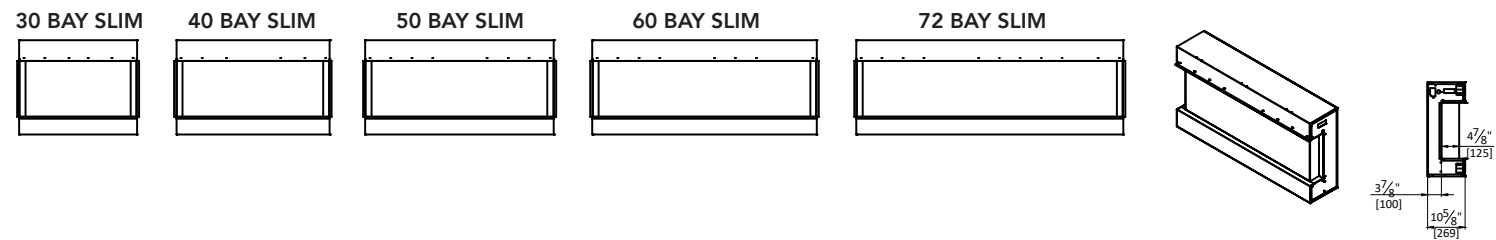

FOUR INSTALLATION CONFIGURATIONS

- All 3 sides of glass visible
- Left side visible
- Right visible
- Front only for an extra deep (14 1/4") fireplace

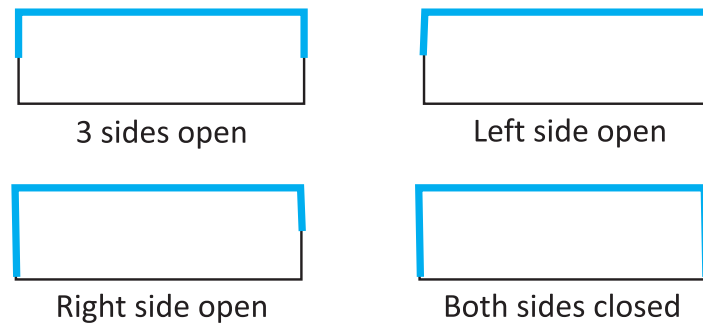

WM



WM-74 electric fireplace



WM-34 electric fireplace

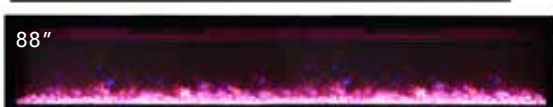

The WM series offers a choice of two flame patterns, Amantii's traditional diffused flame appearance and a new realistic flame style. The WM features the multi-color FIRE & ICE® flame presentation and boasts a true clean face display unencumbered by unsightly heat vents. Ambient canopy lighting illuminates decorative media adding another element of dimension. The slim design allows for versatile applications, inside or outside, including semi-flush mount within 2 x 4 wall and the standardized sizing allows for hassle free installation at any stage of your project.

KEY FEATURES: WM



Install option

Can be fully recessed
Can be semi-flush mounted* within a 2x4 wall. *SYM-XS surround required



Heater & Fan

Flame operates with or without heat, perfect for zone heating



Ambient Canopy Lighting

Choose from 13 colors of light to illuminate decorative media from above



Flame Styles

Two flame style patterns - standard and more traditional - you choose!



FIRE & ICE® Flame presentation

Choose from combinations of yellow, orange, blue, violet & rose colored flames



Touch Pad

For convenient control of features with temperature display

	WM-34	WM-42	WM-50	WM-60	WM-74	WM-88	WM-100
Volts	120 AC / 60 Hz	120 AC / 60 Hz	120 AC / 60 Hz	120 AC / 60 Hz	120 AC / 60 Hz	120 AC / 60 Hz	120 AC / 60 Hz
Amps	13	13	13	13	13	13	13
Watts	1200	1200	1200	1200	1200	1200	1200
Heater On	1200 max / 600 watts low	1200 max / 600 watts low	1200 max / 600 watts low	1200 max / 600 watts low	1200 max / 600 watts low	1200 max / 600 watts low	1200 max / 600 watts low
No Heater	22	22	22	22	22	22	22
Rotor Motor	1 at 5 watts	1 at 5 watts	1 at 5 watts	1 at 5 watts	1 at 5 watts	1 at 5 watts	1 at 5 watts
Height, Width, Depth	15 5/8" x 32 3/8" x 5 1/2"	15 5/8" x 42 1/4" x 5 1/2"	15 5/8" x 50 1/4" x 5 1/2"	15 5/8" x 60 1/4" x 5 1/2"	15 5/8" x 72 3/8" x 5 1/2"	15 5/8" x 80 1/4" x 5 1/2"	15 5/8" x 100 1/4" x 5 1/2"
BTU	5000	5000	5000	5000	5000	5000	5000

Hidden venting and no grills. The heater is located at the top of the unit allowing heat to cascade down in front of the glass.

IN THE BOX

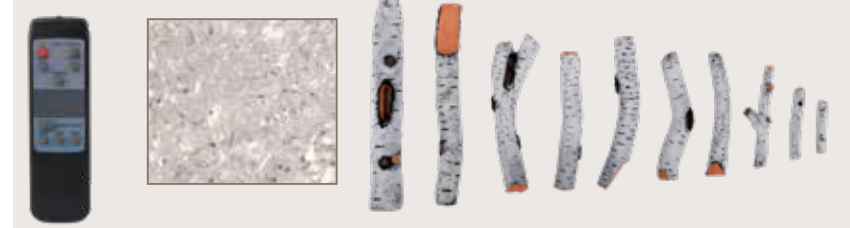

OPTIONAL SURROUNDS

For WM fireplaces only. See page 16 for more details.

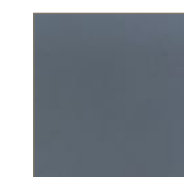

Dark Grey

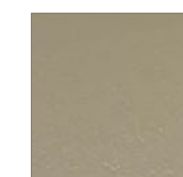

Bronze



WM-42 electric fireplace



WM-50 electric fireplace

WM SURROUND OPTIONS

OPTIONAL SURROUNDS

Add a designer touch to your space with a beautifully finished Dark Grey or Bronze colored surround. These decorative surrounds will compliment all WM fireplaces: 34", 42", 50", 60", 74", 88", 100". The surrounds will arrive in a separate package.

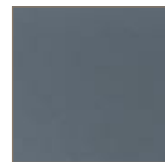

Dark Grey

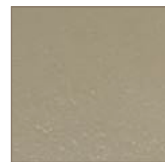

Bronze

FOR SEMI-FLUSH MOUNT INSTALLATION

For rooms where space may be at a premium, WM models can also be partially recessed within a 2 x 4 wall. The unit will sit 2" outside of the wall with 4" of the unit mounted inside.

- This install option requires the Semi-Flush Mount Surround (SYM-XS) to finish the look of the fireplace.
- The Semi-Flush Mount Surround has a black finish and has a depth of 2 1/4"
- The Semi-Flush Mount Surround must be purchased separately. Ships in a separate box.
- **This application is only applicable to the WM models**

CLEAN FACE NO UNSIGHTLY VENTING

Unlike models made by other manufacturers, WM models are unencumbered by unsightly venting. Venting and grills take away from the aesthetics of a fireplace and the WM series have some of the biggest glass viewing areas in the industry. You'll see more of what is important - a beautiful, warm and comforting flame display.

HASSLE FREE INSTALLATION

The Remii has been made with standardized unit sizing. This means that the opening for the fireplace can be made at any stage of a build, the appliance can be easily installed and finished with the included surround at the end of a project. The surround beautifully completes the fireplace without the need for finicky or costly finishing.

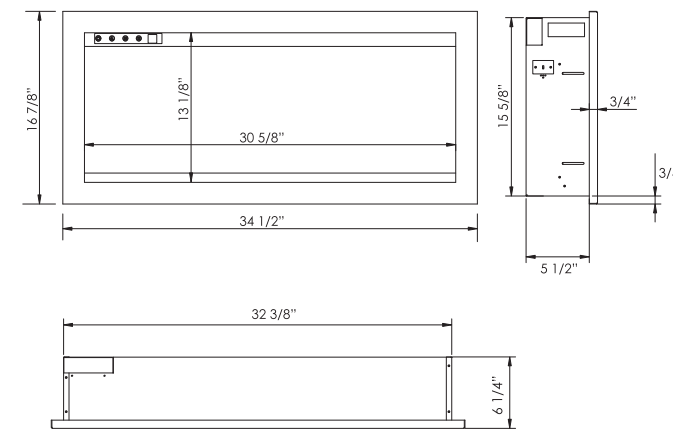

WM-34

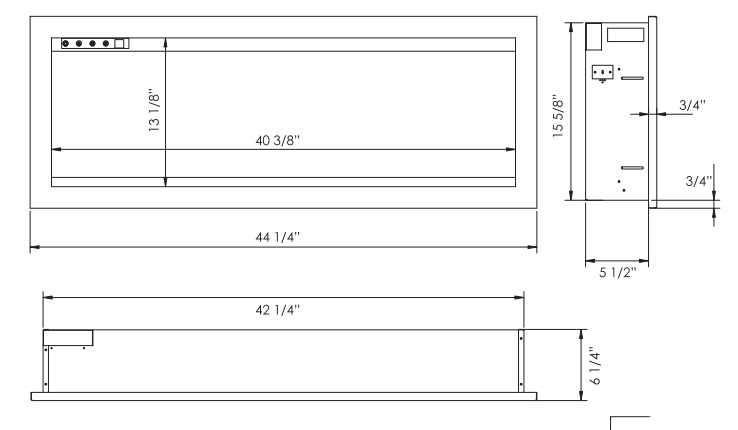

WM-42

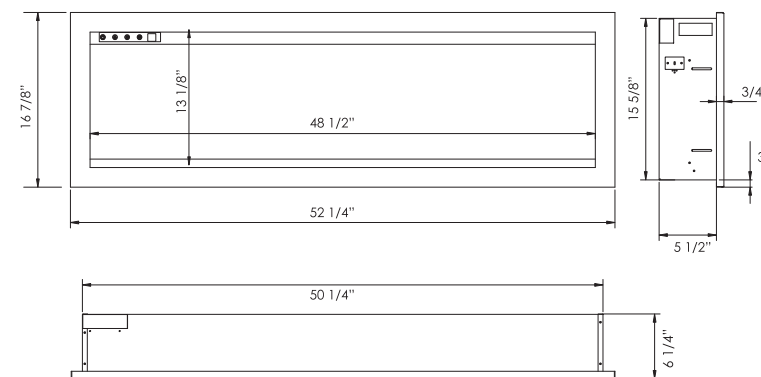

WM-50

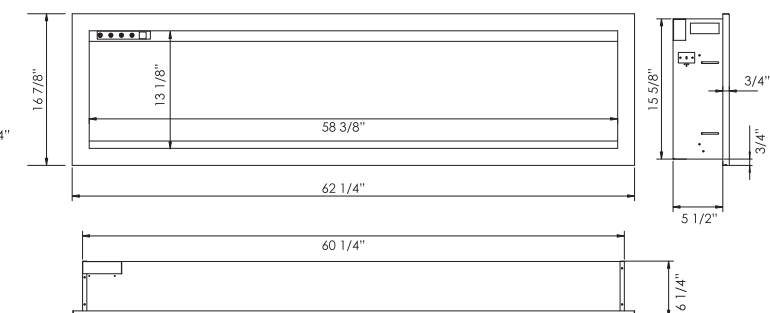

WM-60

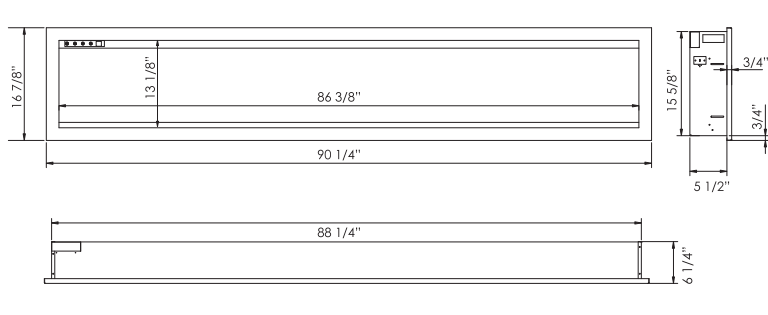
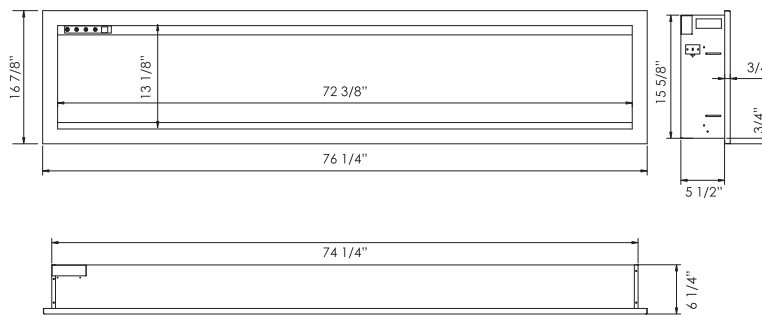

WM-74

WM-88

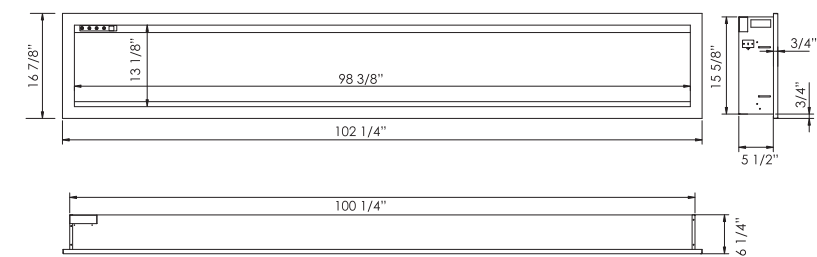

WM-100



WM-SLIM



WM-SLIM-65 electric fireplace



WM-SLIM-55 electric fireplace

The NEW WM-SLIM electric fireplace offers the perfect blend of style and functionality to any room it's placed in. Defined by its slender depth proportions and streamlined integration into any contemporary domain, the WM-SLIM is a both a familiar emblem of welcome and conversation.

A elegant flame display dances across the back of the fireplace, creating movement that is sure to catch your eye. The heat settings can be adjusted with a simple push of a button. During the warmer months, you can set the flames to display without heat – making it perfect to use all year long.

KEY FEATURES: WM-SLIM

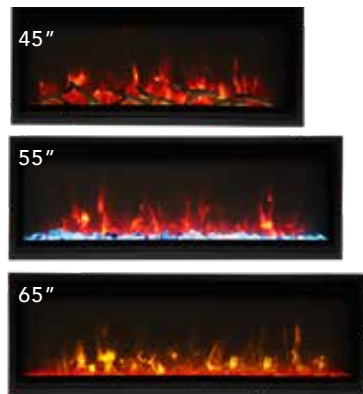

- FIRE & ICE © Flame presentation - three light strips allow for yellow, orange and red colored flames
- Rated for Indoor Applications. Not approved for outdoor use
- 2 Stage heater
- Hard wire ready
- Thermostat hard wire ready
- Flame can operate without heat
- Single remote control for flame & heater included
- Heater is located in inner top of the unit, thus allowing the heat to cascade down over the top of the glass
- Can produce up to 4096 BTU of heat
- Hidden venting allows for a true clean face appearance
- Trim is required and units come with a Black Surround in the box.

Optional decorative color surrounds are available for purchase

	WM-SLIM-45	WM-SLIM-55	WM-SLIM-65
Volts	120 AC / 60 Hz	120 AC / 60 Hz	120 AC / 60 Hz
Watts	1200	1200	1200
No Heater	25W	25W	25W
Height, Width, Depth	19 7/8" x 44 1/8" x 4"	19 7/8" x 54 1/8" x 4"	19 7/8" x 59 1/8" x 4"
Gross Weight	62 lbs	86 lbs	108 lbs
Plug Location	Left Side	Left Side	Left Side
Cord Length	70 7/8"	70 7/8"	70 7/8"
Rough Wall Opening	44" x 20 3/8"	54" x 20 3/8"	64" x 20 3/8"
BTU	5000	5000	5000

IN THE BOX

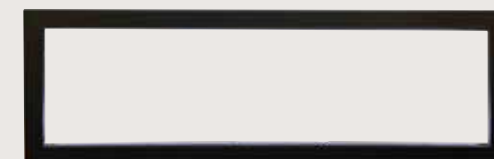
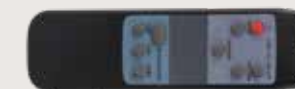

WM-SLIM-45 electric fireplace

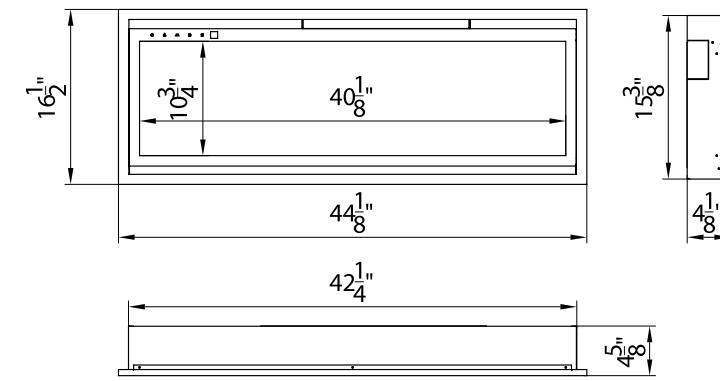

WM-SLIM-45

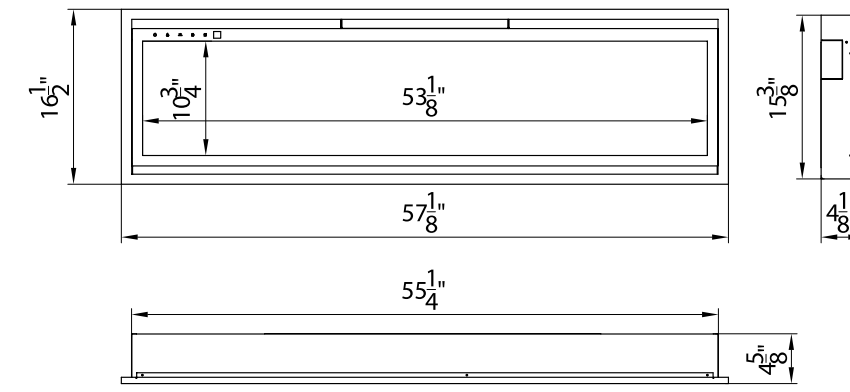

WM-SLIM-55

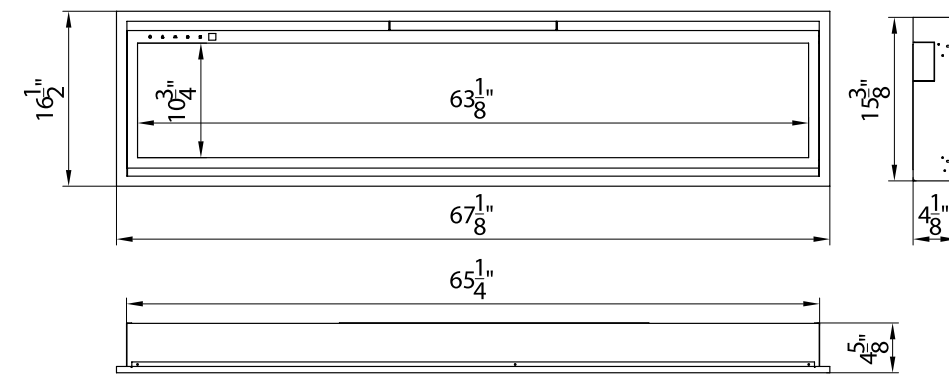

WM-SLIM-65

CLASSIC XTRA SLIM



Classic-SLIM-30 electric fireplace



Classic-SLIM-26 electric fireplace

The NEW Classic Xtra Slim electric fireplace offers the perfect blend of style and functionality to any room it's placed in. Defined by its slender depth proportions and streamlined integration into any contemporary domain, the Classic Xtra Slim is a both a familiar emblem of welcome and conversation.

A elegant flame display dances across the back of the fireplace, creating movement that is sure to catch your eye. The heat settings can be adjusted with a simple push of a button. During the warmer months, you can set the flames to display without heat – making it perfect to use all year long.



KEY FEATURES: CLASSIC XTRA SLIM

- Modern and sleek in design, this unit can be mounted or recessed into any 2" x 4" wall
- Unsurpassed, realistic flames can be enjoyed with or without the use of heat, allowing for year round use
- Clean and Seamless in Design: this fireplace features a full frame viewing area
- WiFi controls come standard
- Remote App- total control of your fireplace from the convenience of your mobile device
- Operate this fireplace from the comfort of your favorite spot with the included, full feature, remote control
- 2 Heater settings Low 750W High 1500
- 5118 BTU's
- Accessories Included: Clear glass diamonds, black powder coated surround and a full feature remote control
- 11 multi colors of up lighting that accent from the tray
- Flame options include: yellow, orange, and red. 5 settings in each color, so you can cycle through
- 3 Speed motor sets the flame speed option
- Smart Heater Control - Auto mode feature allows for the unit to operate under your ideal temperature setting
- Perfect for any commercial or residential space

	CLASSIC-SLIM-26	CLASSIC-SLIM-30	CLASSIC-SLIM-33
Volts	120 AC / 60 Hz	120 AC / 60 Hz	120 AC / 60 Hz
Watts	1500	1500	1500
No Heater	25W	25W	25W
Height, Width, Depth	16 3/4 x 25 1/4 x 4 1/8	19 1/8 x 29 3/8 x 4 1/8	22 1/4 x 31 3/4 x 4 1/8
Gross Weight	38.58 lbs	43.29 lbs	55.11 lbs
Plug Location	Left Side	Left Side	Left Side
Cord Length	70 7/8"	70 7/8"	70 7/8"
Rough Wall Opening			
BTU	5118	5118	5118

IN THE BOX

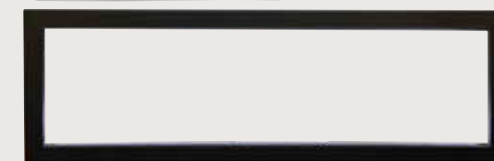

OPTIONAL LOG SET





Classic-SLIM-33 electric fireplace

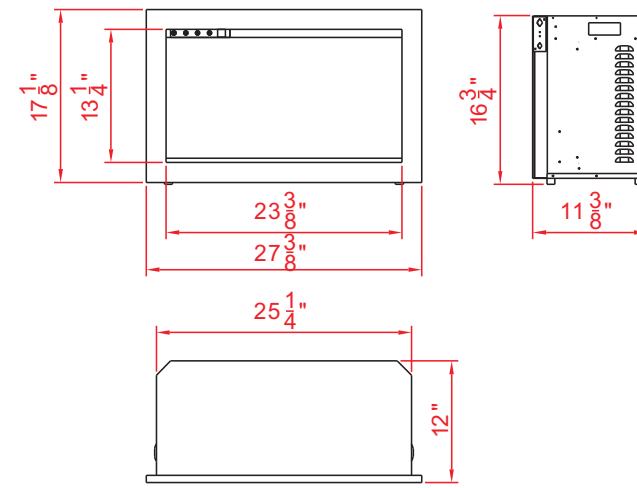

CLASSIC-SLIM-26

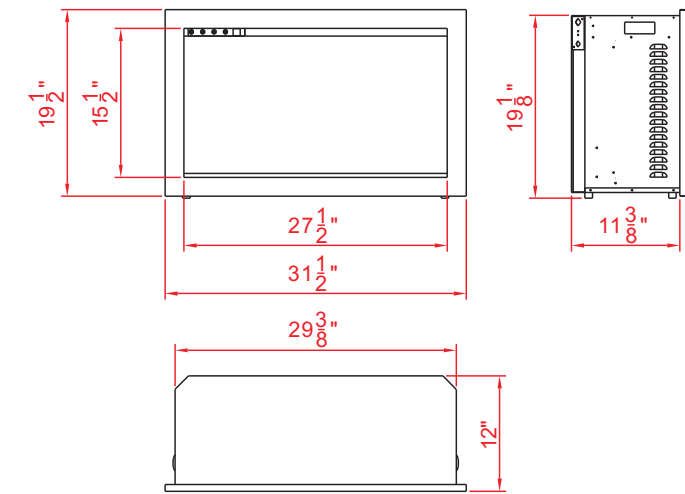

CLASSIC-SLIM-30

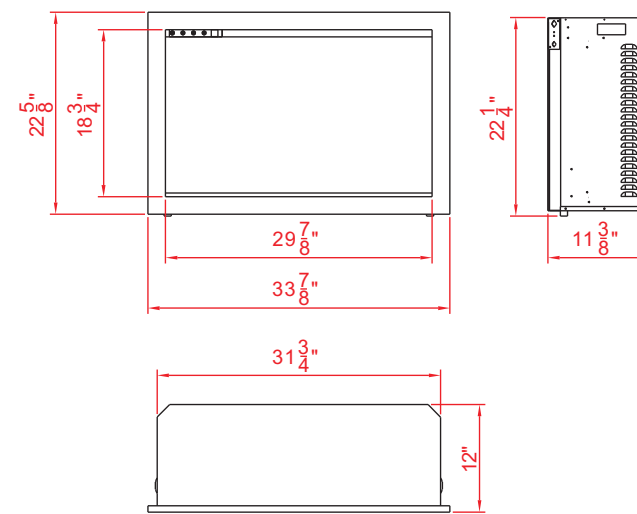

CLASSIC-SLIM-33

FIRE GLASS & MEDIA OPTIONS

Our decorative fire glass media is a beautiful addition to your electric fireplace. Turn your fireplace into an expressive work of art by simply adding our decorative fire glass media. Our fire glass adds a distinctly modern feel to your electric fireplace - mix colors and textures for a unique appearance.

Always wear protective gloves when handling fire glass media. One 5lb container of media will cover 1 square foot.



AMSF-GLASS-01



AMSF-GLASS-02



AMSF-GLASS-03

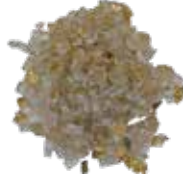

AMSF-GLASS-04



AMSF-GLASS-05



AMSF-GLASS-06



AMSF-GLASS-07



AMSF-GLASS-08



AMSF-GLASS-09



AMSF-GLASS-10



AMSF-GLASS-11



AMSF-GLASS-12



AMSF-GLASS-13

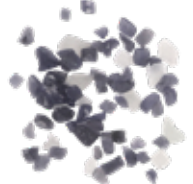

AMSF-GLASS-14

DESIGNER MEDIA KITS

DESIGN-MEDIA-DRIFT-15PCE



DESIGN-MEDIA-RUSTIC-14PCE



DESIGN-MEDIA-BIRCH-15PCE

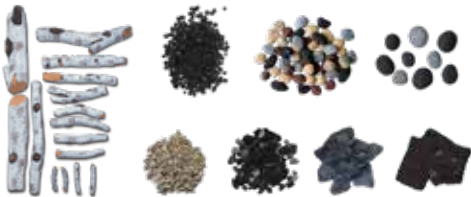

DESIGN-MEDIA-LOG-6PCE



DECORATIVE MEDIA OPTIONS



FI-105-Diamond



FI-106-Diamond



FI-107-Diamond

Images are not to scale, please visit your local dealer to view the actual accessories. Variations in the color and shade are inherent in all printing processes, the actual colors may vary slightly from those shown in this brochure. Please visit your local dealer to view a sample.

Note: Log sets and Designer Media Kits will fit in all sizes of the following models - Deep and Extra Tall ONLY

For Designer Media Kits, depending on the size of the model, not all media included may be required to be used.

Remii-Brochure-US

May 2022

Distributed By:

We reserve the right to update products, specifications and dimensions are subject to change. Please refer to the product manual to verify measurements and clearance requirements. All local building codes must be followed.



Visit our online showrooms at:



www.remii.com

Phone: 800.986.1864